

GAZEBO
15'2" x 16'9"

PAVER PATIO
47'11" x 17'8"

DECK
52'9" x 28'11"

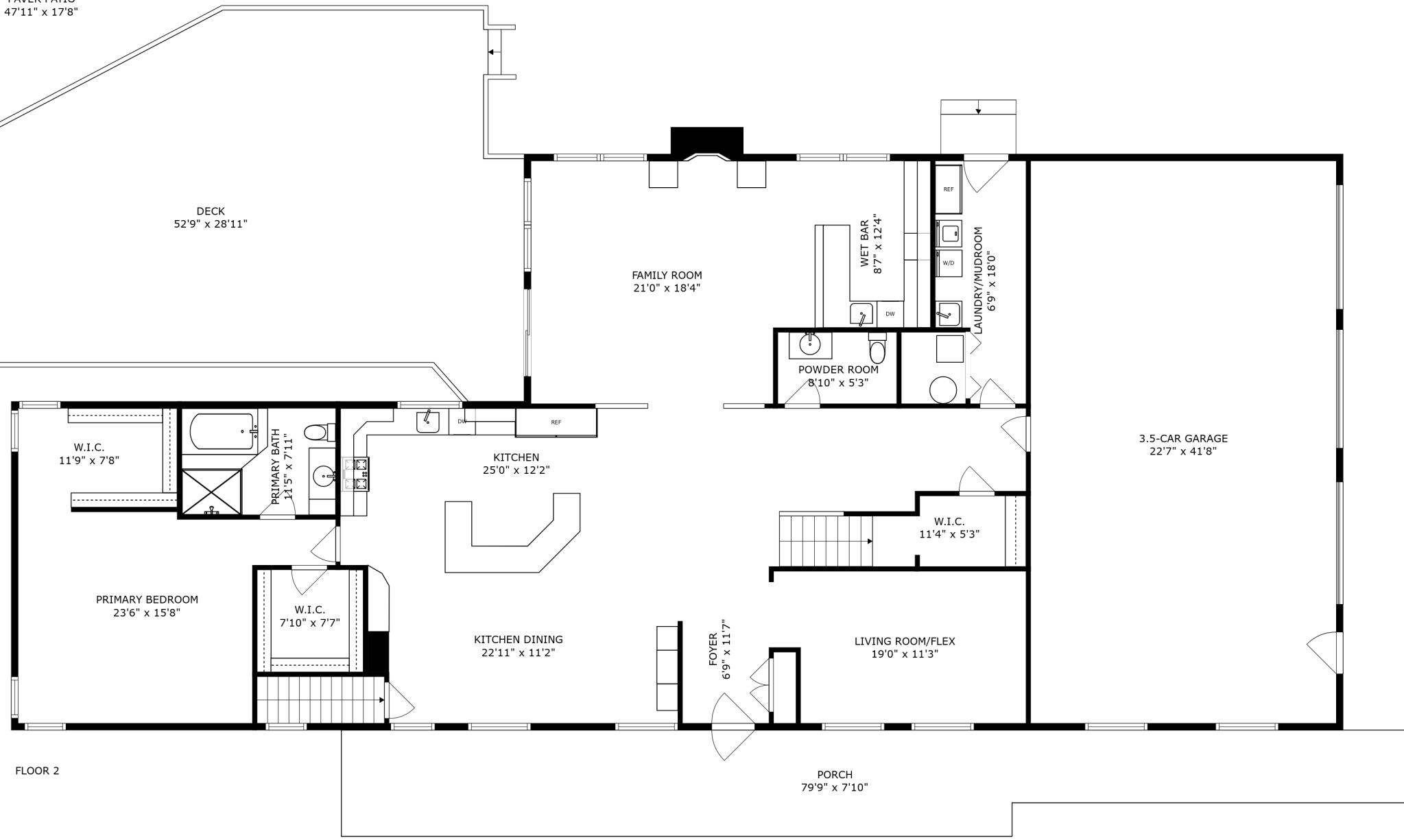

FLOOR 2

PORCH
79'9" x 7'10"

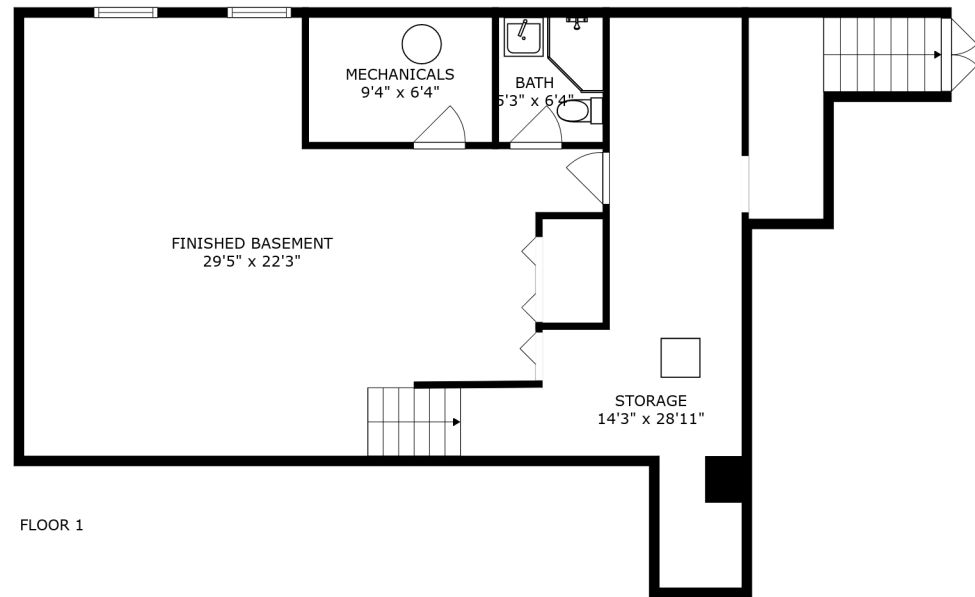

FLOOR 1

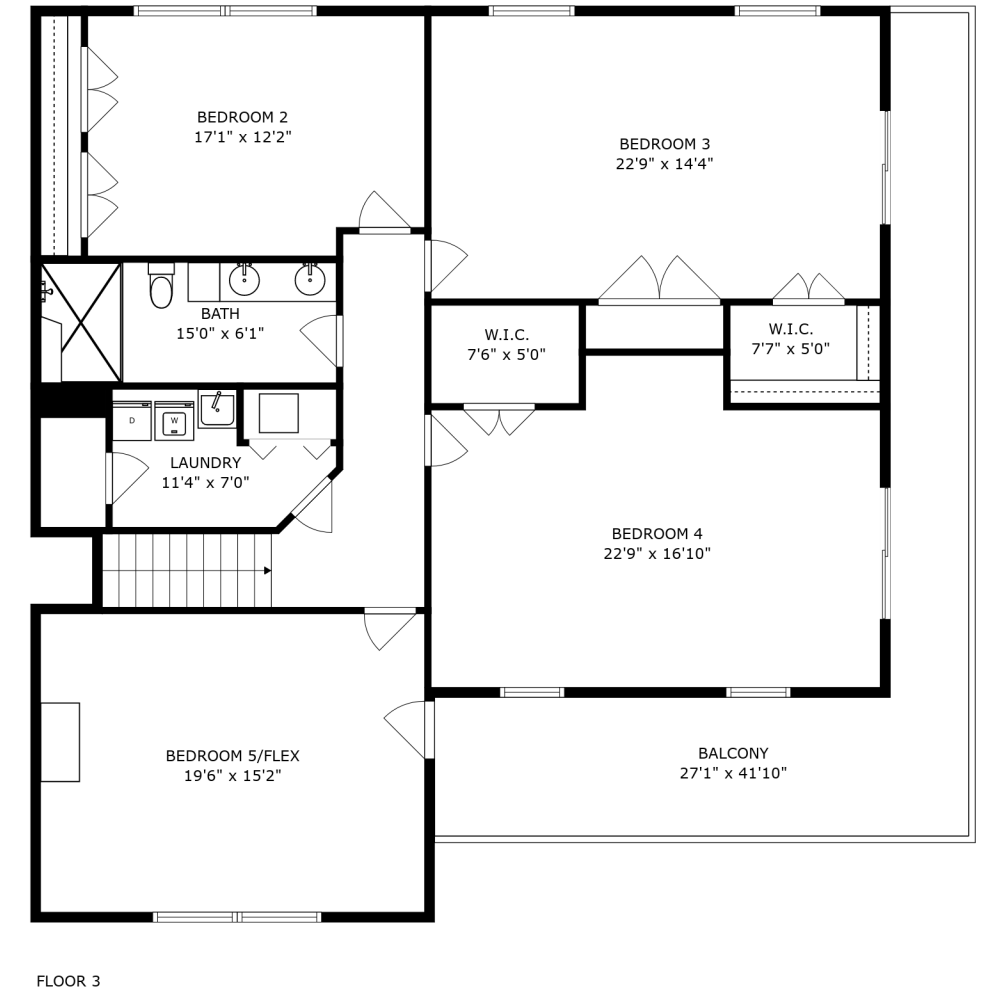

FLOOR 3

SIZES AND DIMENSIONS ARE APPROXIMATE, ACTUAL MAY VARY.



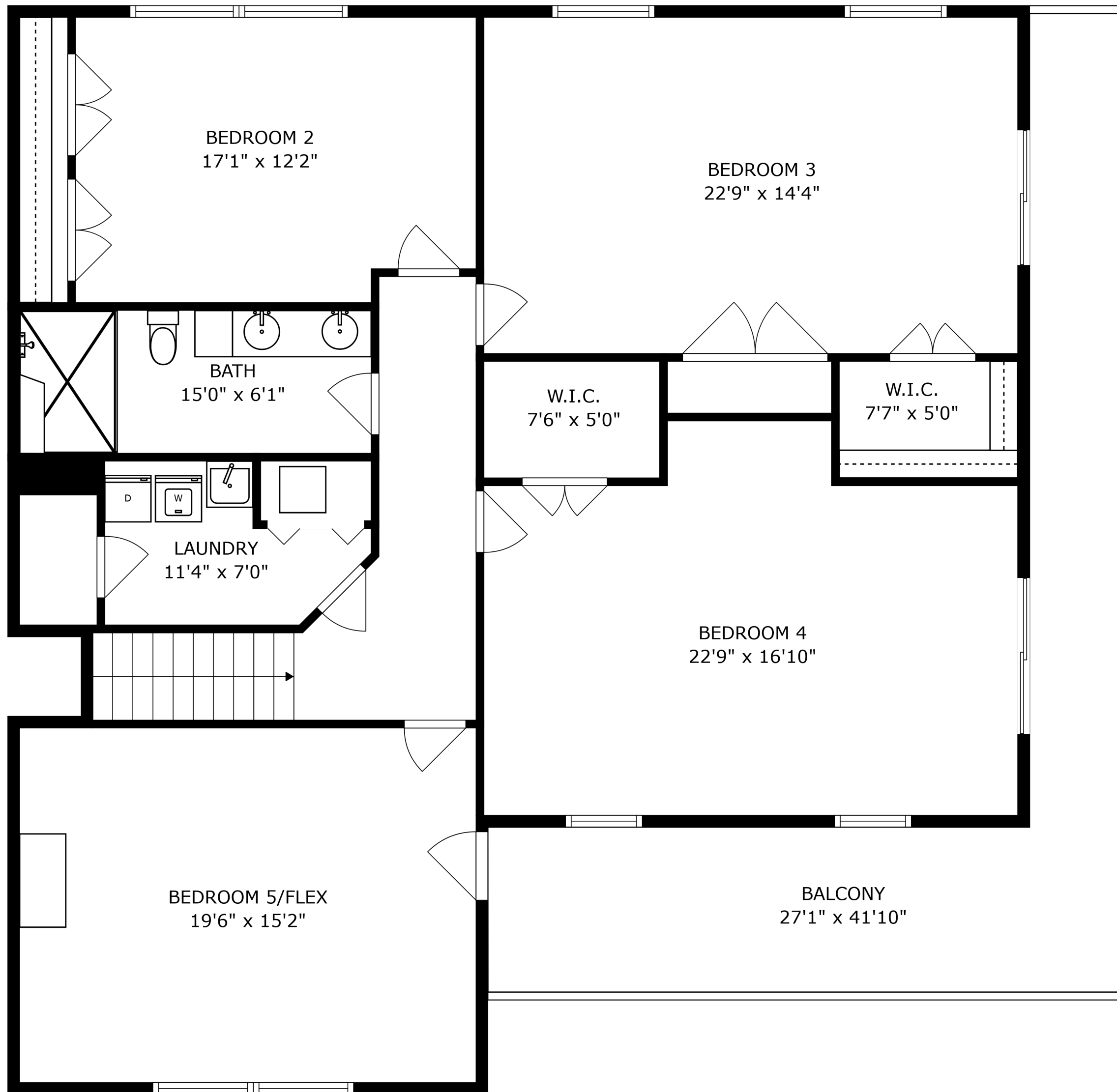

SIZES AND DIMENSIONS ARE APPROXIMATE, ACTUAL MAY VARY.



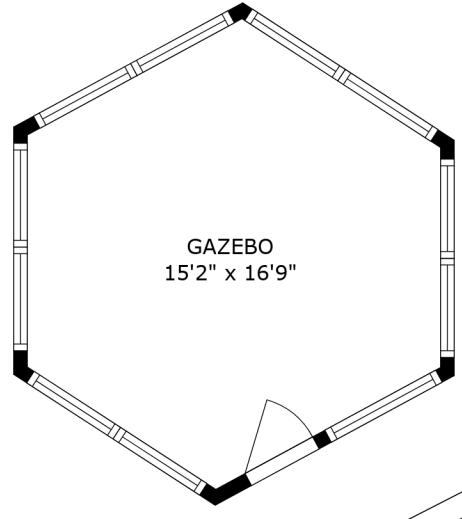

GAZEBO
15'2" x 16'9"

PAVER PATIO
47'11" x 17'8"

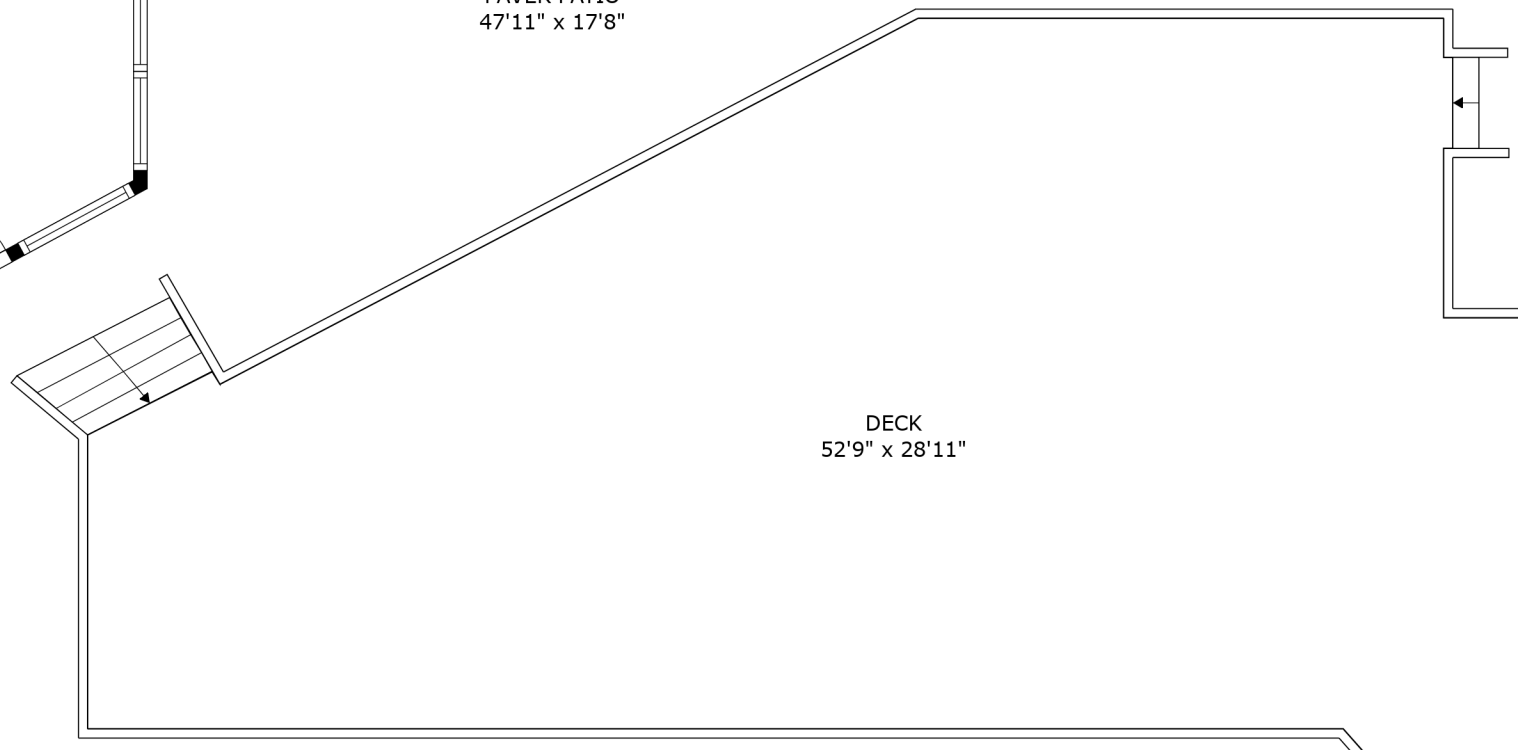

DECK
52'9" x 28'11"

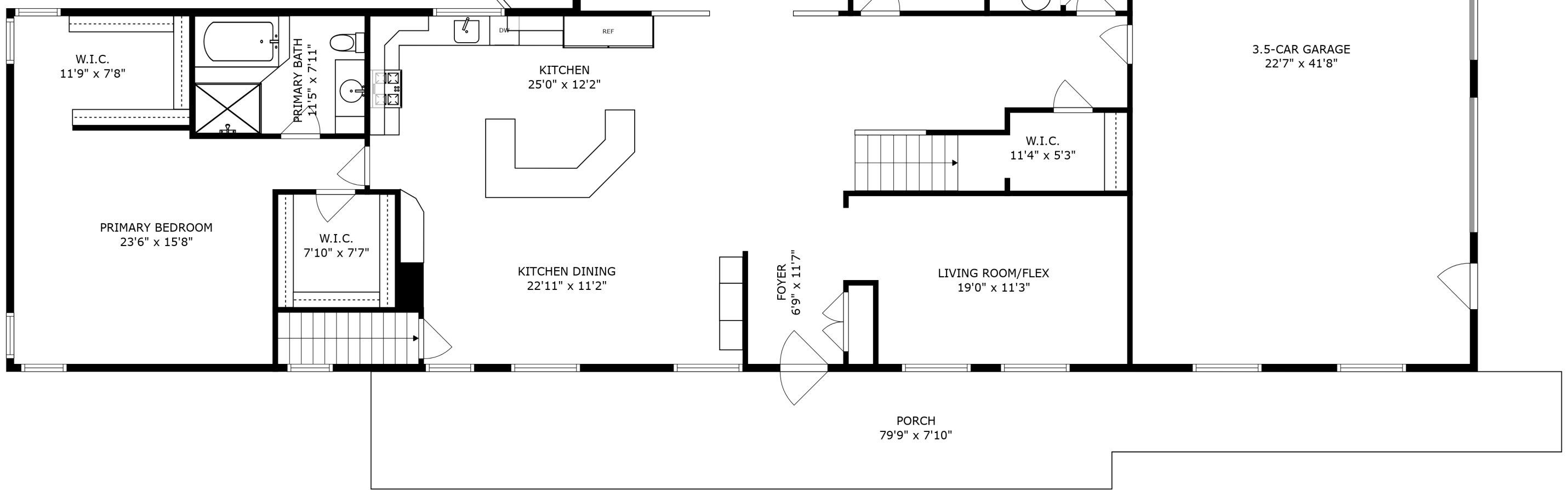

W.I.C.
11'9" x 7'8"

PRIMARY BATH
11'5" x 7'11"

KITCHEN
25'0" x 12'2"

PRIMARY BEDROOM
23'6" x 15'8"

W.I.C.
7'10" x 7'7"

KITCHEN DINING
22'11" x 11'2"

FOYER
6'9" x 11'7"

LIVING ROOM/FLEX
19'0" x 11'3"

W.I.C.
11'4" x 5'3"

POWDER ROOM
8'10" x 5'3"

WET BAR
8'7" x 12'4"

LAUNDRY/MUDROOM
6'9" x 18'0"

3.5-CAR GARAGE
22'7" x 41'8"

PORCH
79'9" x 7'10"

SIZES AND DIMENSIONS ARE APPROXIMATE, ACTUAL MAY VARY.



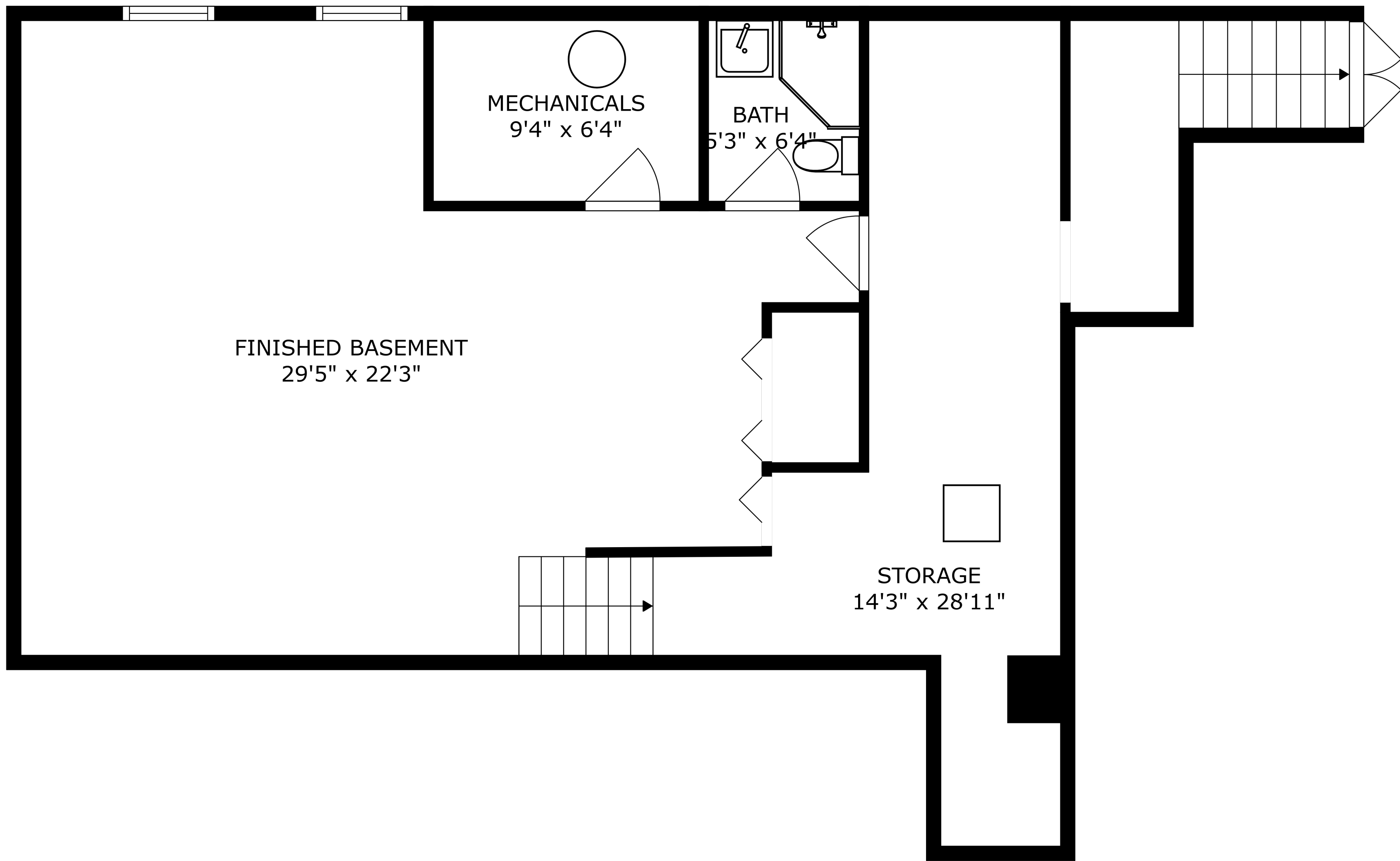

FINISHED BASEMENT
29'5" x 22'3"

MECHANICALS
9'4" x 6'4"

BATH
5'3" x 6'4"

STORAGE
14'3" x 28'11"



SIZES AND DIMENSIONS ARE APPROXIMATE, ACTUAL MAY VARY.