

FLOOR 2

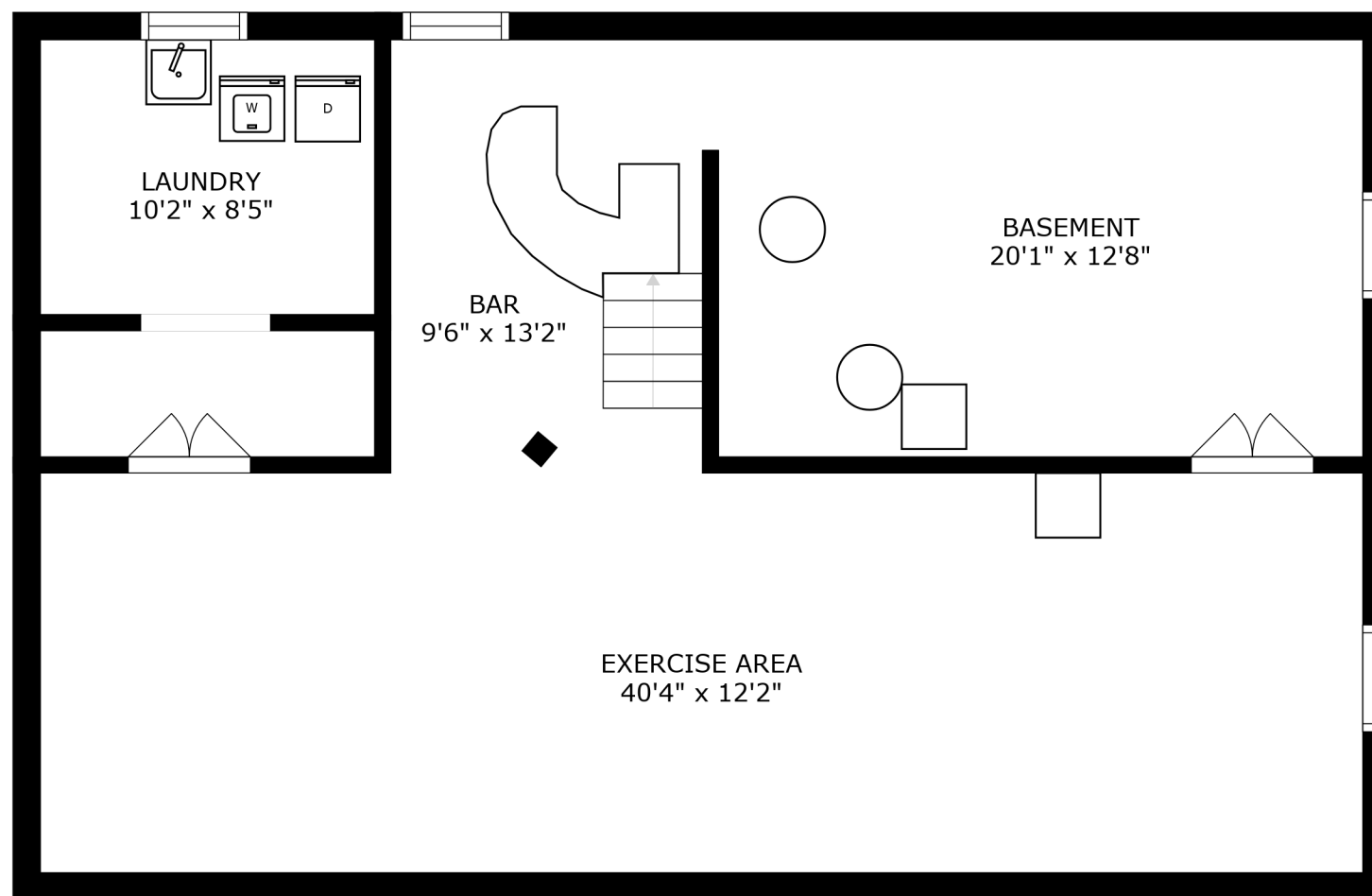

FLOOR 1

SIZES AND DIMENSIONS ARE APPROXIMATE, ACTUAL MAY VARY.

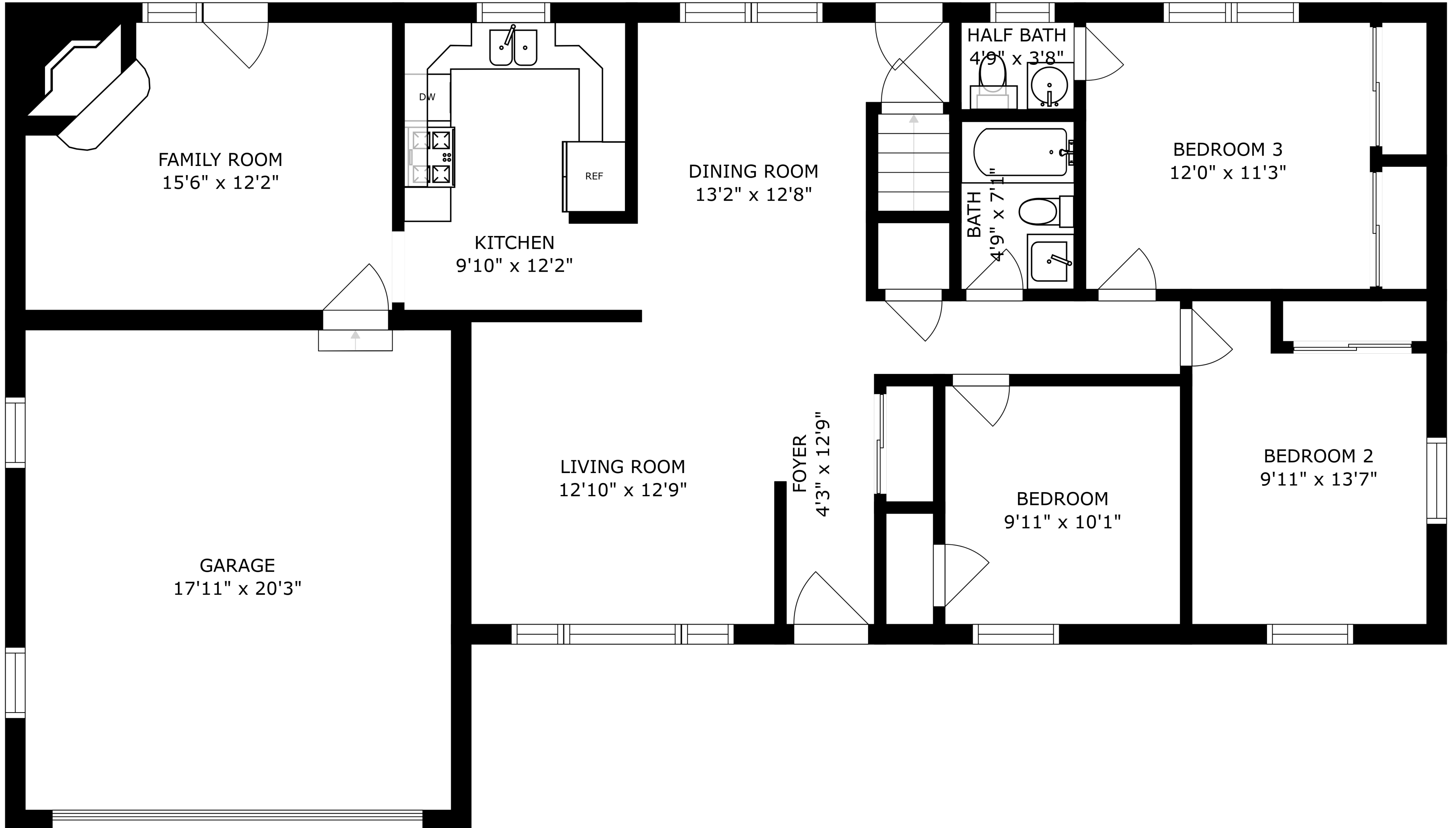

SIZES AND DIMENSIONS ARE APPROXIMATE, ACTUAL MAY VARY.

LAUNDRY
10'2" x 8'5"

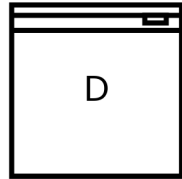
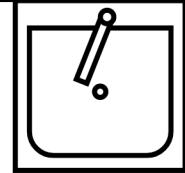

BAR
9'6" x 13'2"

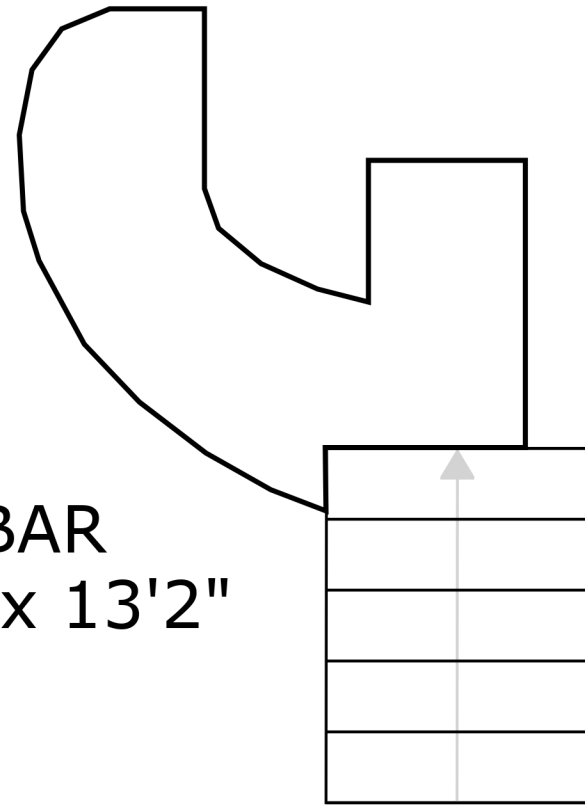

BASEMENT
20'1" x 12'8"

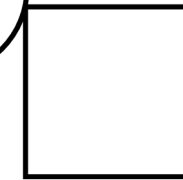
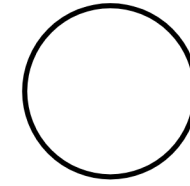
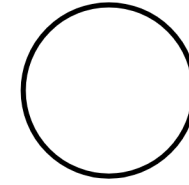

EXERCISE AREA
40'4" x 12'2"